

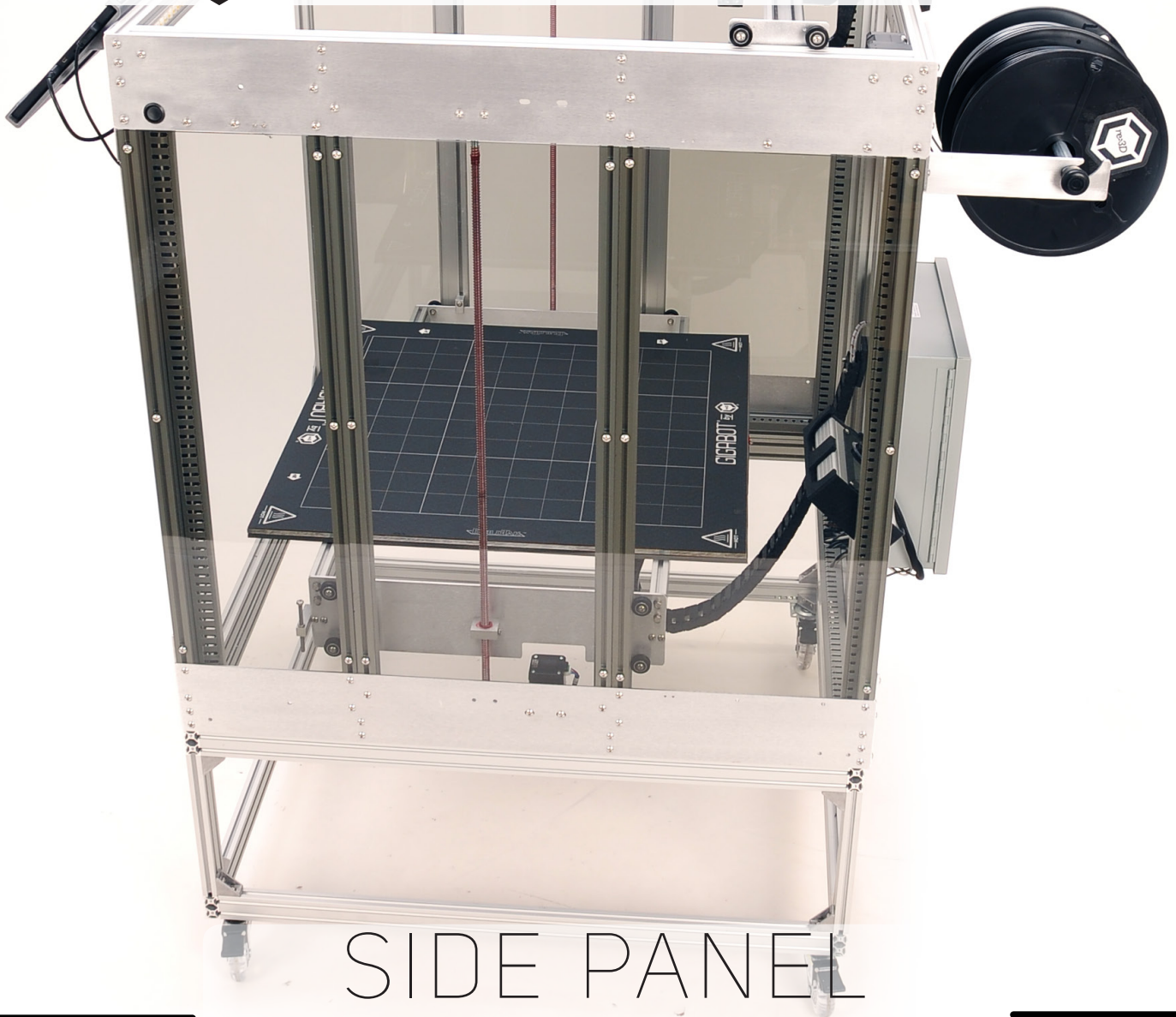

GIGABOT[®]

THINK BIG,
PRINT HUGE



SIDE PANEL
INSTALLATION



INTRODUCTION

THANK YOU FOR PURCHASING THE SIDE PANEL RETROFIT KIT FROM re:3D Inc.®!

This upgrade will let you install side panels for your Gigabot®. You will find that this is especially helpful in restricting access to the Z-axis Acme screws, the bed, and other moving parts during operation. The full side panel kit will include extra panels to fully cover the left and right sides.

REFERENCES & HELPFUL DOCUMENTS :

Some external resources may be helpful during the assembly process. For example, knowing the correct names for different parts on the Gigabot®, or proper use of certain tools. Resources that we thought may be helpful have been linked to at the end of this guide.

VIDEO INSTRUCTIONS :

If you prefer a video guide, please search for “re3D Tech” on YouTube and find our “Side Panel Installation” video.

LEGALESE

READ INSTRUCTIONS : All the safety and operating instructions should be read before the printer is operated.

RETAIN INSTRUCTIONS : The safety and operating instructions should be retained for future reference.

HEED WARNINGS : All warnings on the product and in the operating instructions should be adhered to.

FOLLOW INSTRUCTIONS : All operating and use instructions should be followed.

CLEANING : Unplug this product from the wall outlet before cleaning. Do not use liquid or aerosol cleaners.

ATTACHMENTS : Do not use attachments or enhancements not recommended by the product manufacturer as they may cause hazards.

WATER AND MOISTURE : Do not use Gigabot near water - for example, near a bath tub, wash bowl, kitchen sink, or laundry tub, in a wet basement, or near a swimming pool, and the like.

PLACEMENT : Do not place this product on an unstable cart, stand, tripod, bracket, or table. The product may fall, causing serious injury to a child or adult, and serious damage to the product. Use only with a cart, stand, tripod, bracket, or table recommended by the manufacturer, or sold with the product. Any mounting of the product should follow the manufacturer's instructions, and should use a mounting accessory recommended by the manufacturer.

VENTILATION : Slots and openings in the cabinet are provided for ventilation and to ensure reliable operation of the product and to protect it from overheating, and these openings must not be blocked or covered. The openings should never be blocked by placing the product on a bed, sofa, rug, or other similar surface. This product should not be placed in a built-in installation such as a bookcase or rack unless proper ventilation is provided or the manufacturer's instructions have been adhered to.

POWER SOURCES : This product should be operated only from the type of power source indicated on the marking label. If you are not sure of the type of power supply to your home consult your appliance dealer or local power company. For products intended to operate from battery power, or other sources, refer to the operating instructions.

GROUNDING OR POLARIZATION : This product may be equipped with either a polarized 2-wire AC line plug (a plug having one blade wider than the other) or a 3-wire grounding type plug, a plug having a third (grounding) pin. The 2-wire polarized plug will outlet, try reversing the plug. If the plug still fails to fit, contact your electrician to replace your obsolete outlet. Do not defeat the safety purpose of the polarized plug. The 3-wire grounding type plug will fit into a grounding type power outlet. This is a safety feature. If you are unable to insert the plug into the outlet, contact your electrician to replace your obsolete outlet. Do not defeat the safety purpose of the grounding type plug.

POWER-CORD PROTECTION : Power-supply cords should be routed so that they are not likely to be walked on or pinched by items placed upon or against them, paying particular attention to cords at plugs, convenience receptacles, and the point where they exit from the product.

LIGHTNING : For added protection for this product during a lightning storm, or when it is left unattended and unused for long periods of time, unplug it from the wall outlet and disconnect the antenna or cable system. This will prevent damage to the product due to lightning and power-line surges.

OVERLOADING : Do not overload wall outlets, extension cords, or integral convenience receptacles as this can result in a risk of fire or electric shock. A product and cart combination should be moved with care. Quick stops, excessive force, and uneven surfaces may cause the product and cart combination to overturn.

OBJECT AND LIQUID ENTRY : Never push objects of any kind into this product through openings as they may touch dangerous voltage points or short-out parts that could result in a fire or electric shock. Never spill liquid of any kind on the product.

TABLE OF CONTENTS

OVERVIEW	1
LEGEND	2
BEFORE YOU BUILD	3
BUILD GUIDE	5
BILL OF MATERIALS - PARTIAL SIDE PANELS	5
BILL OF MATERIALS - FULL SIDE PANELS	6
TOOLS YOU'LL NEED	6
A : INSTALLATION	7



OVERVIEW

Partial side panels -
26 9/16" x 12"

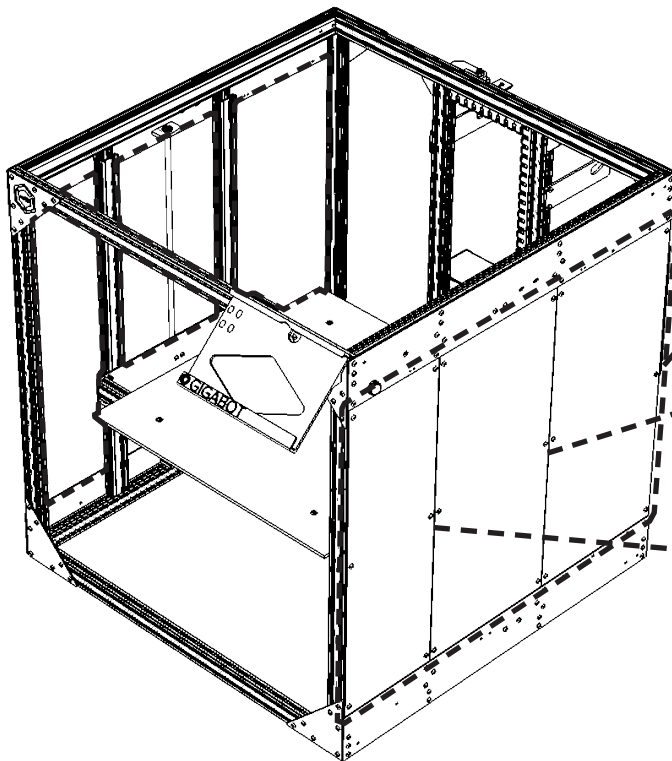
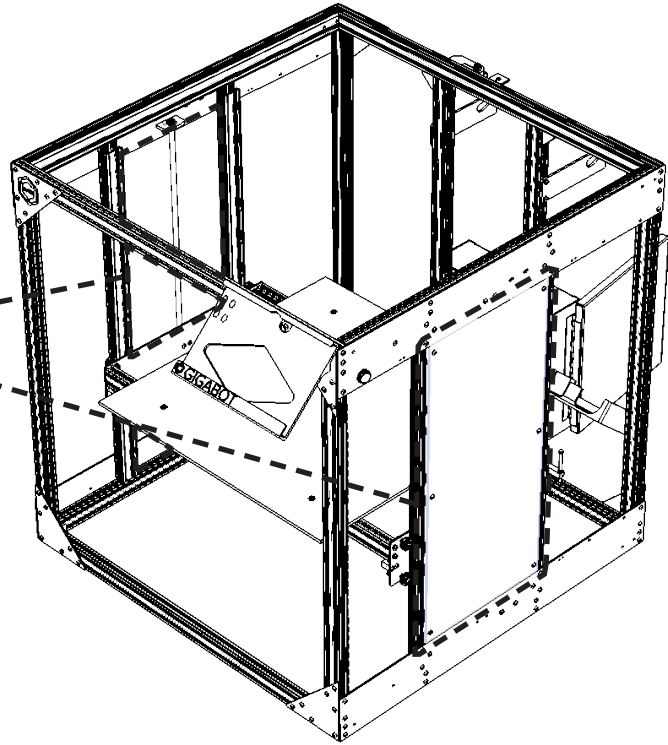

Full side panels -
26 9/16" x 12 1/4"

Full side panels -
26 9/16" x 12"

Full side panels -
26 9/16" x 8 3/4"

**Full Gigabot® rendering is for illustrative purposes only and may not reflect the final construction of your Gigabot®*

LEGEND

LOCATE



PLACE

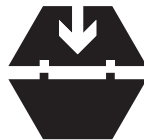

REMOVE

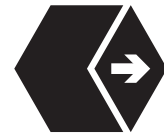

FASTEN/SCREW

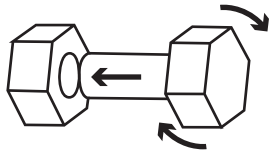

ALIGN



INSERT

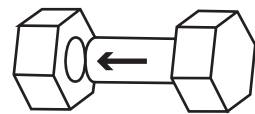

Objects of importance are outlined with dotted lines

BEFORE YOU BUILD

IT'S HIP TO BE SQUARE!



When assembling the Gigabot®, it is essential to work on a flat surface and to carefully square perpendicular parts as much as possible. This is especially important while assembling the side plates, Z-axis uprights and vertical common rails, bed frame, upper and lower cross rails, and bridge assembly. Use large clamps to help square up frames if needed.

Make good use of grease during assembly. These will help hold the eccentric spacers when installing the V-groove wheels and also keep them from damaging the side plates or end trucks during adjustment. Likewise, it will ensure smooth, quiet operation when applied to the Z-axis ACME threaded rods.

THE USES OF GREASE

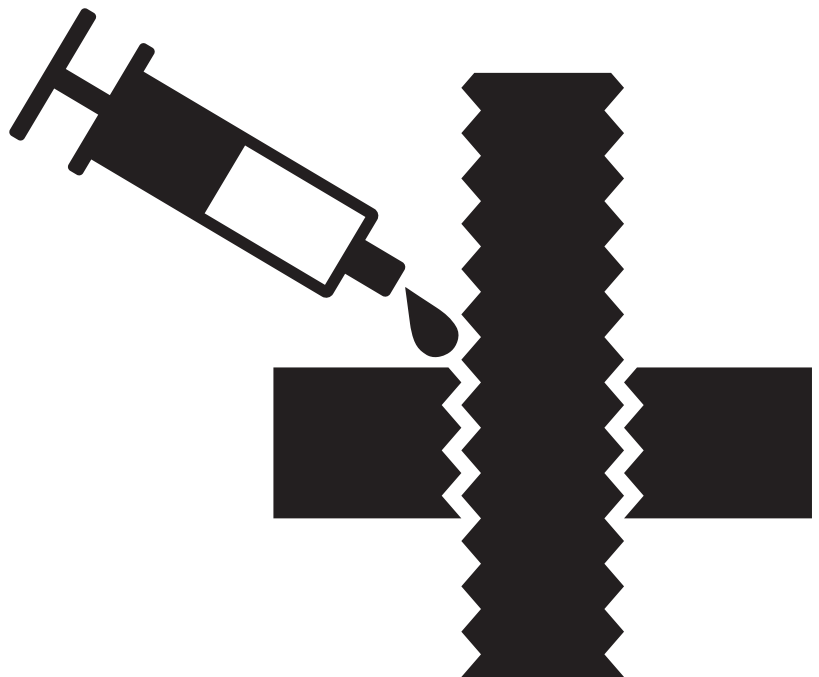

T-NUTS, HOW DO THEY WORK?

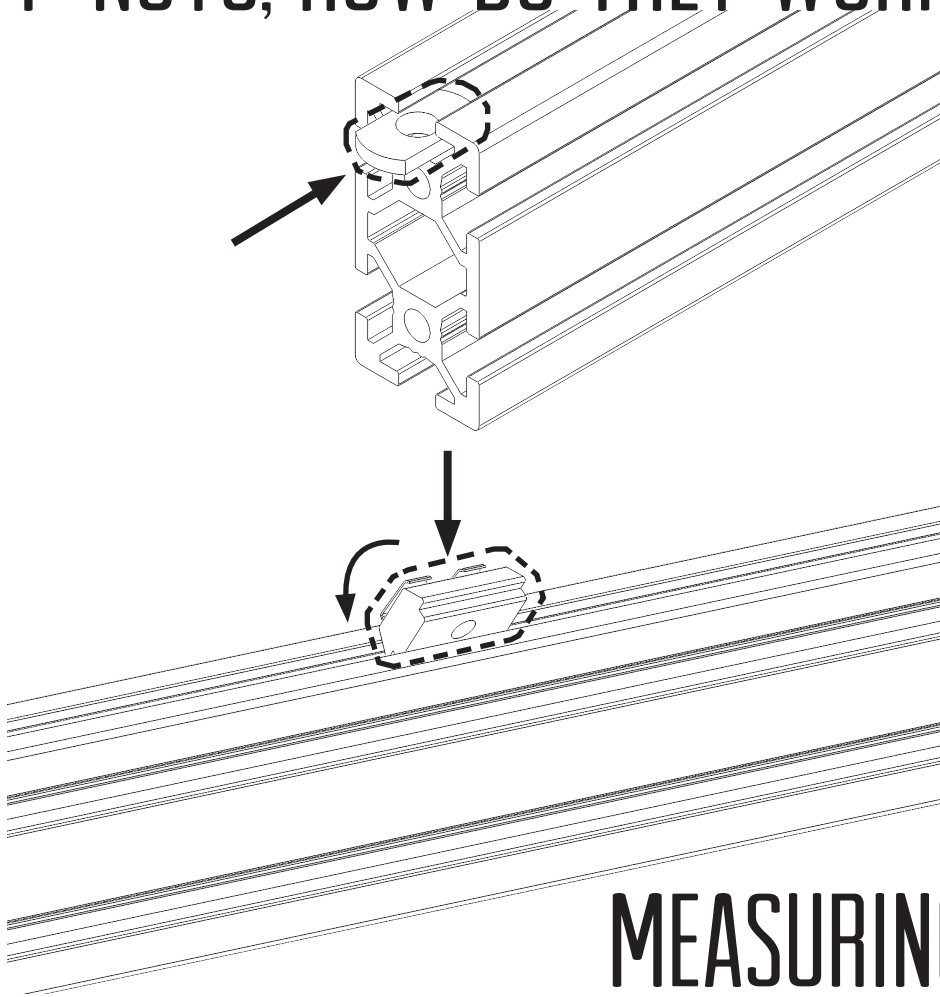

T-nuts are an essential part of assembling the Gigabot®. These are inserted into the aluminum extrusion in order to fasten parts to the frame. Post assembly T-nuts are also used. These hold their positions well without sliding around, and are useful when installing retrofits.

MEASURING AND MARKING

There are parts of the instructions that suggest marking spots on the Gigabot® to properly place parts. When marking, be sure to only use a pencil--using a permanent marker will leave unsightly marks on the metal!



BUILD GUIDE

BILL OF MATERIALS - PARTIAL SIDE PANELS

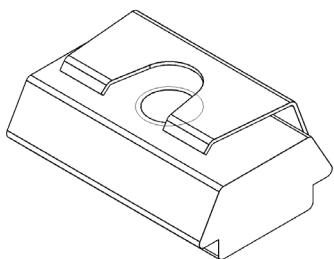

Post assembly T-nuts

12

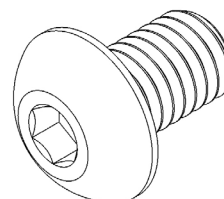

M5x8mm BHCS

12



26 9/16" x 12" side panels

2

BILL OF MATERIALS - FULL SIDE PANELS

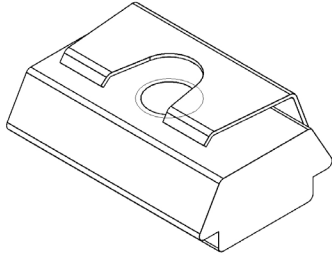

Post assembly T-nuts

36

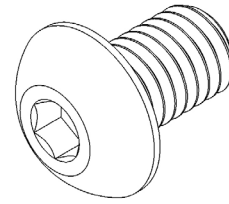

M5x8mm BHCS

36



26 9/16" x 8 3/4" side panels

2



26 9/16" x 12" side panels

2



26 9/16" x 12 1/4" side panels

2

TOOLS YOU'LL NEED

- 3MM ALLEN KEY

A : INSTALLATION

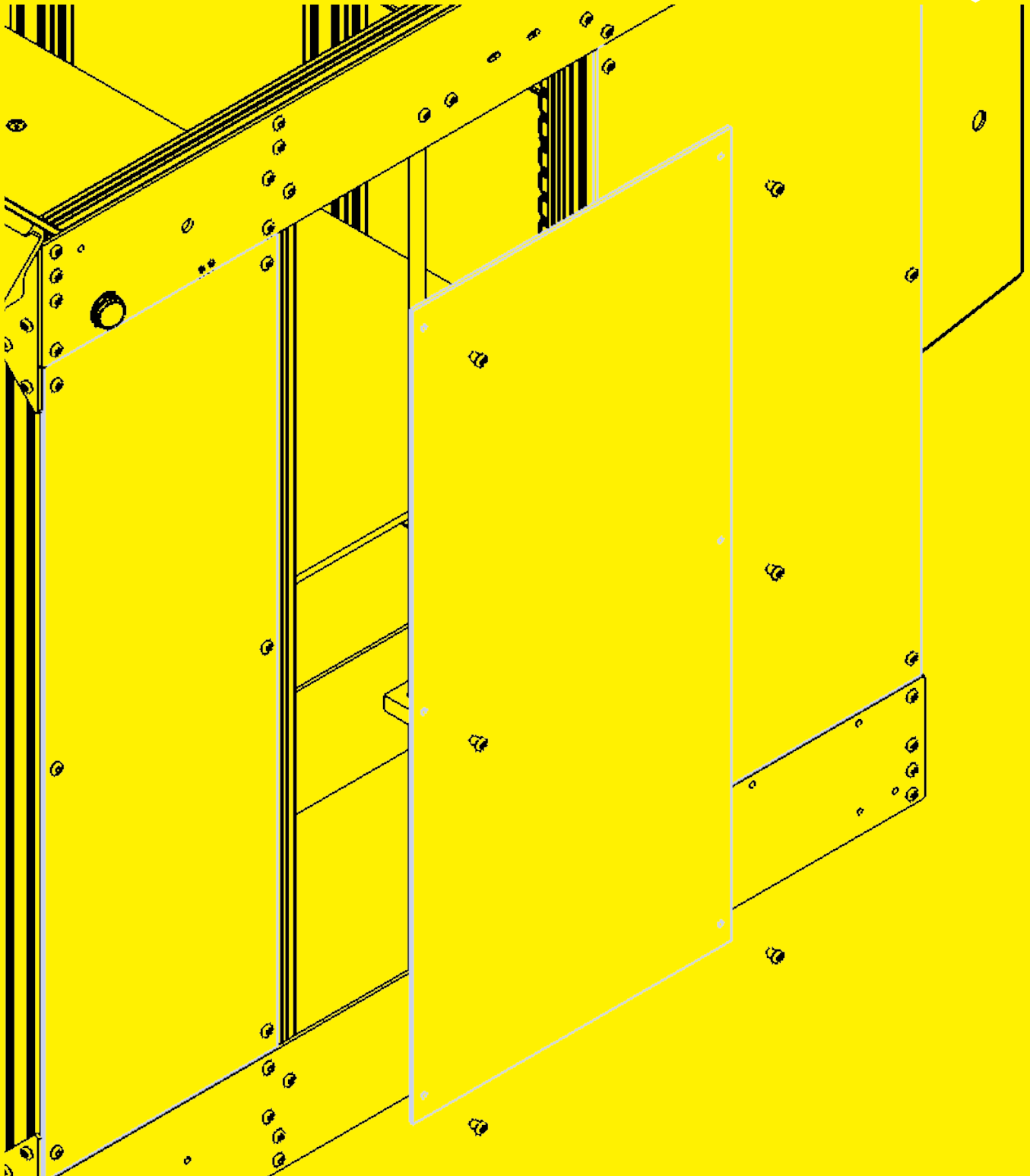

WARNING

PLEASE be sure that you have turned off and unplugged your Gigabot before attempting any modifications!

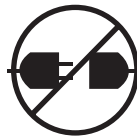

WARNING

There may be sharp edges on panels after cutting process. Observe accordingly and wear protective gloves as needed.

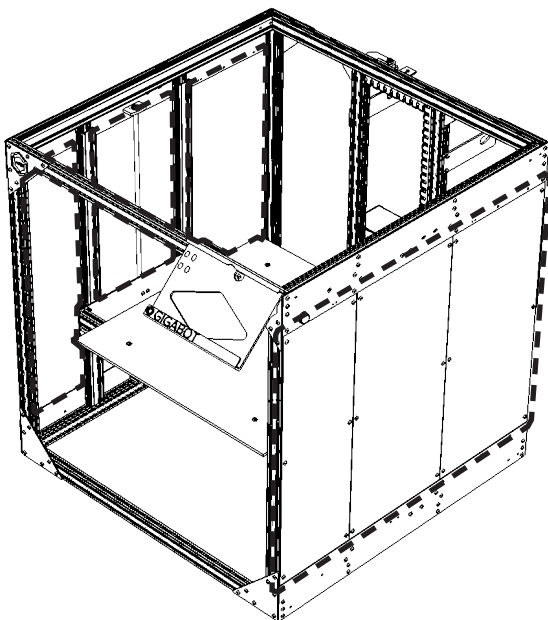

A3



Without removing protective film on panels, identify the location of each panel

Refer to overview for placement if needed

A4



Use each panel to approximate the location of each T-nut

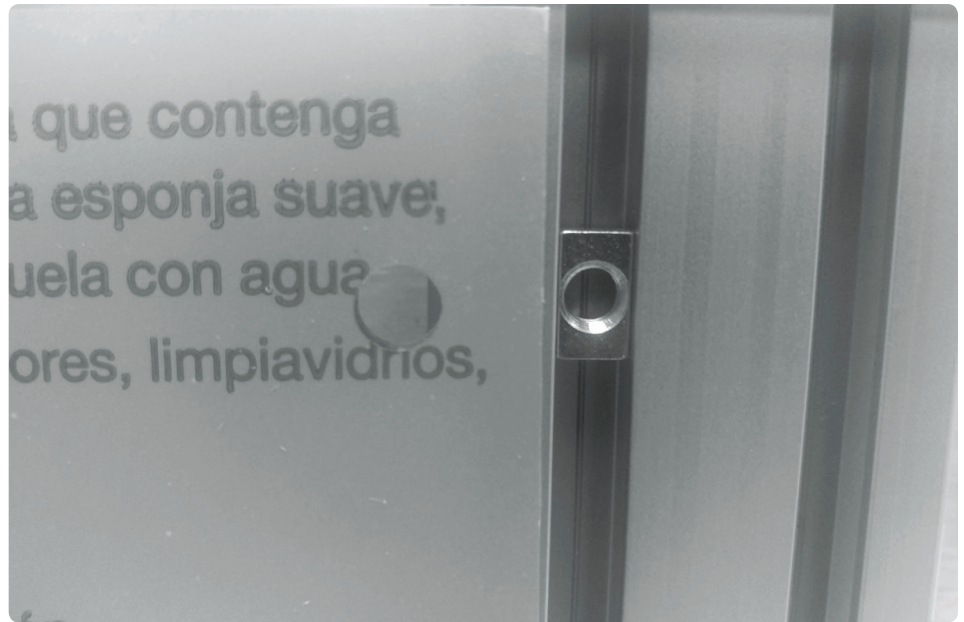

A5

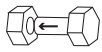

Insert T-nuts inside rail



6 T-nuts for each panel

A6



Remove film from panel





A7



Place panel in corresponding location



A8

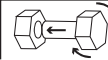

After removing the protective film, use 3mm Allen Key to fasten 1 or 2 x M5x8mm BHCS to loosely hold panel to frame



A9



Align the rest of the T-nuts to the panel holes



A10

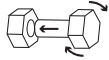

Fasten the rest of the
M5x8mm BHCS with a 3mm
Allen key

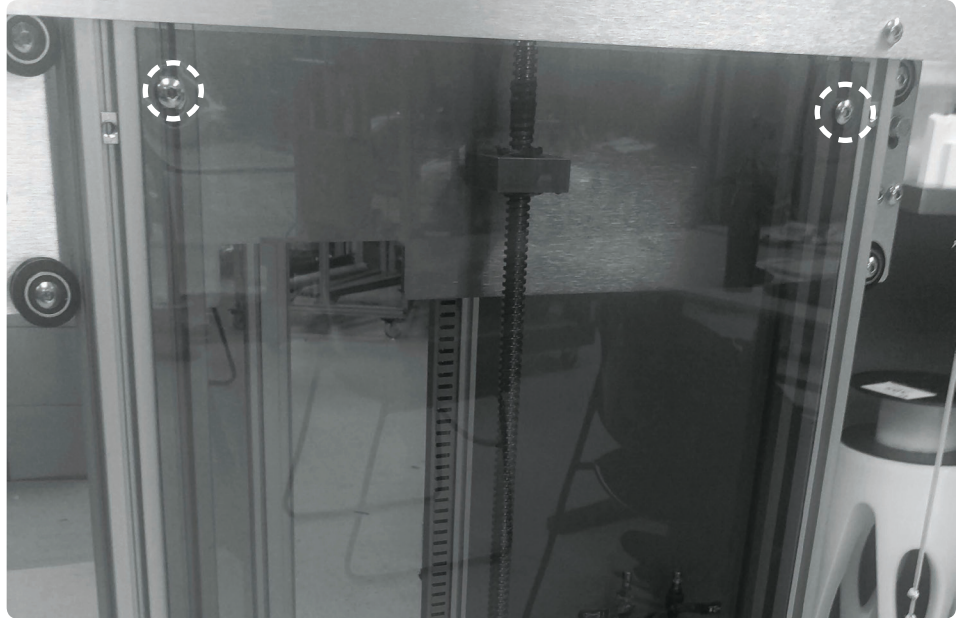

A11

Repeat for all remaining
panels

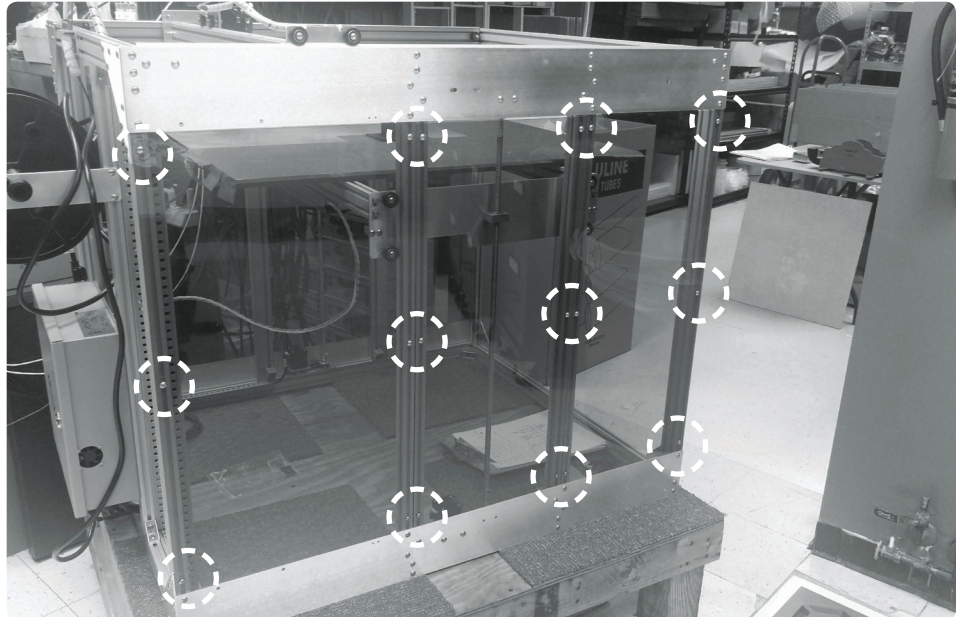

DOUBLE-CHECK YOUR WORK :

Please look over your completed kit and make sure everything has been assembled correctly. If you have further questions, please refer to the video instructions (search “re3D Tech” on YouTube and find “Side Panel Installation” video) or contact us through the channels listed in the conclusion.

NOW IS A GOOD STOPPING POINT...

Acquire beverage of
your choice

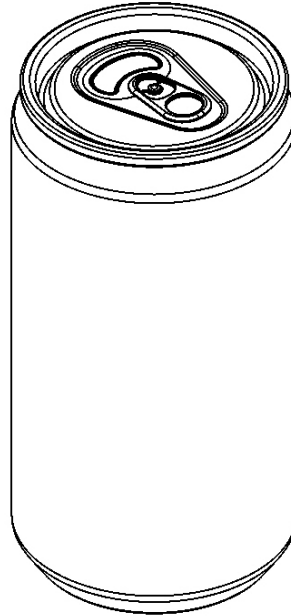

Actuate pull tab

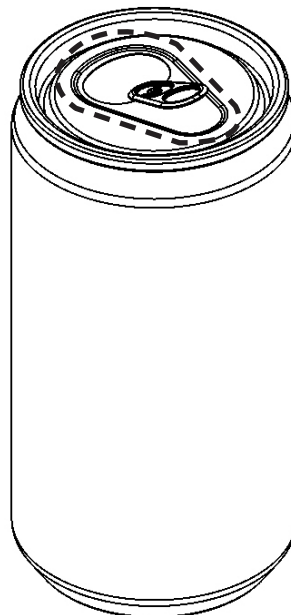

Consume

CONCLUSION

CONGRATULATIONS! YOU HAVE NOW COMPLETED THE SIDE PANEL RETROFIT ON YOUR GIGABOT®.

We are confident that you will find this upgrade very helpful in your every day use of the Gigabot®, but please do not hesitate to contact us for any further issues or questions. Feedback on assembly instructions, support, and other aspects of your experience are welcome. Reach out to us at:

WIKI : wiki.re3d.org

EMAIL : support@re3d.org

PHONE : 512-730-0033

Happy printing!

THINK BIG, PRINT HUGE!

From the re:3D Inc.® team

REFERENCES & DOCUMENTS

**SIDE PANEL
INSTALLATION
MANUAL PDF :**

http://wiki.re3d.org/index.php?title=Retrofit_Instructions

**re:3D Inc.® YouTube
CHANNEL :**

<https://www.youtube.com/user/GigaBot3D>



re:3D Inc.® | re3d.org | support@re3d.org